



# LCC Modelling System

## B 70-22 GWR Style platform mounted footbridge

**All drawings are not in scale.  
Some proportions on drawings may differ from reality.**

For additional elements for modification and extension please visit our website at [www.lcut.co.uk](http://www.lcut.co.uk) or email us at [contact@lcut.co.uk](mailto:contact@lcut.co.uk)

### Bundle contains:

- 1x LCC 70-123L
- 1x LCC 70-123R
- 1x LCC 70-124L
- 1x LCC 70-124R
- 2x LCC 70-125
- 2x LCC 70-126
- 2x LCC 70-127
- 2x LCC 70-128
- 1x LCC 70-129
- 8x LCC 70-130
- 4x crests

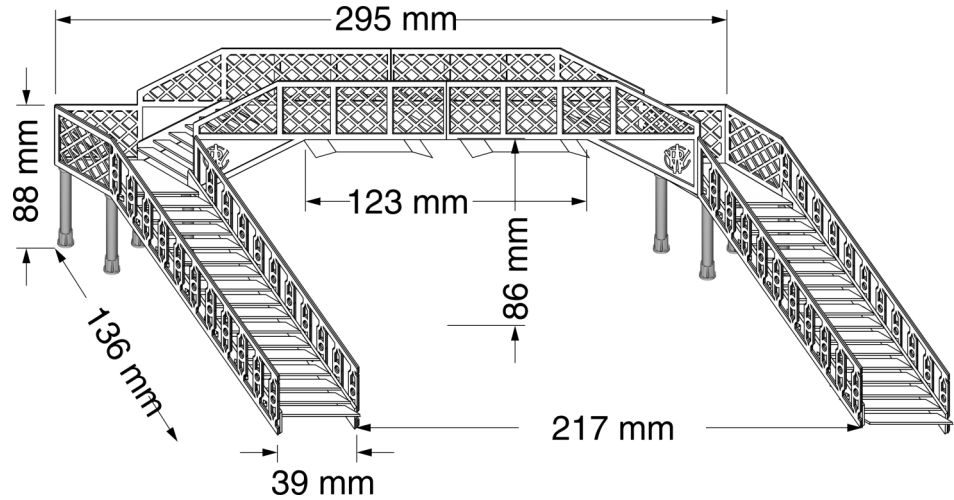

**!** We recommend PVA or any other paper/wood glue for the main fibre board parts and resin based glue for 3D printed parts if present.

### Painting recommendation:

We recommend using acrylic or enamel paints. There is no need to undercoat the surface but it can be done if desired. The material used is porous and relatively forgiving, heavy coats are unlikely to flood the brickwork. If you experience any warping in the material leave it to fully dry and then gently bend it back into shape. Always test any paints in an area that will not be seen or on spare parts/off cuts.

This kit contains parts made from 3D printed photosensitive resin. Care has been taken to make sure they are all clean but if there is any residue it can be wiped off with some IPA or methylated spirit. Do not expose the plastic parts to excessive sunlight before painting to avoid over curing them. Any flashing around bottoms of parts needs be filed away with a fine file. Everything can be painted with either enamel or acrylic paints. Spray paints can also be used.

### BALUSTRADES

First step in the assembly process is to prepare the balustrades and stair sub assemblies. Make sure to prepare the stairs as well as the stair balustrades mirrored. It is possible to assemble the footbridge with staircases ending on opposite sides. In which case assemble all elements in the same sided version. Both LCC 70-123L/R and LCC 70-124L/R have to be joined along the middle line.

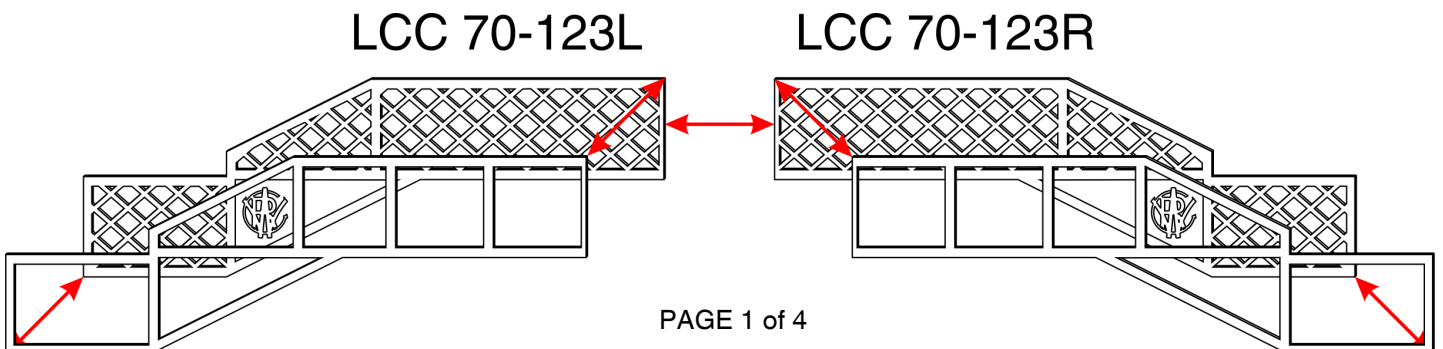

LCC 70-124L

LCC 70-124R

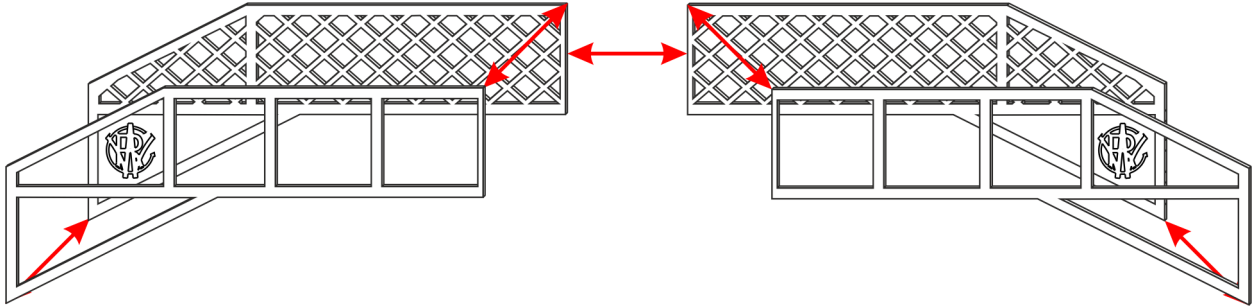

LCC 70-126

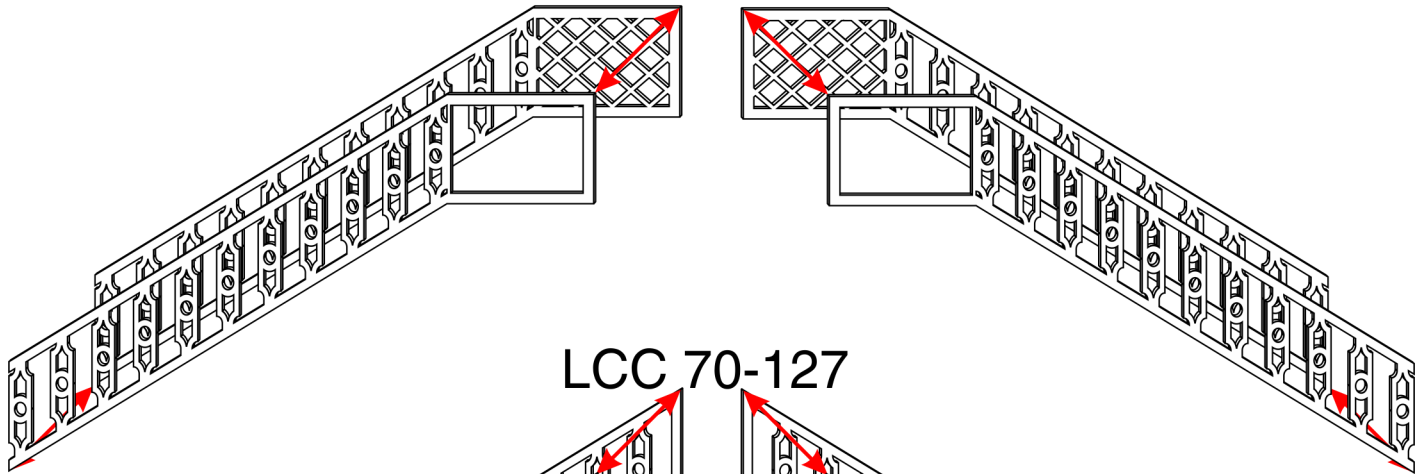

LCC 70-127

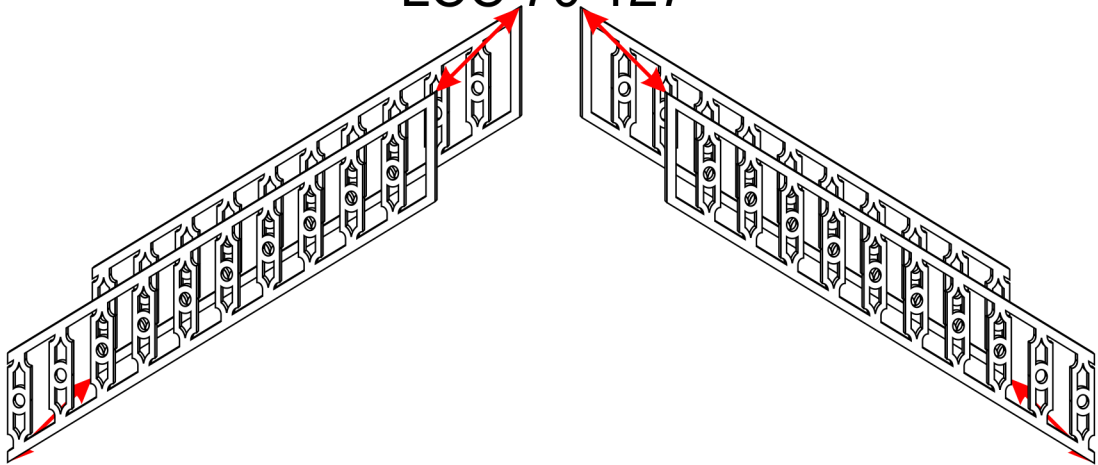

STAIRS

x2

LCC 70-125

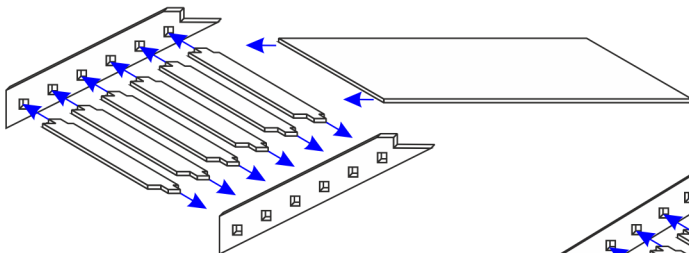

x2

LCC 70-128

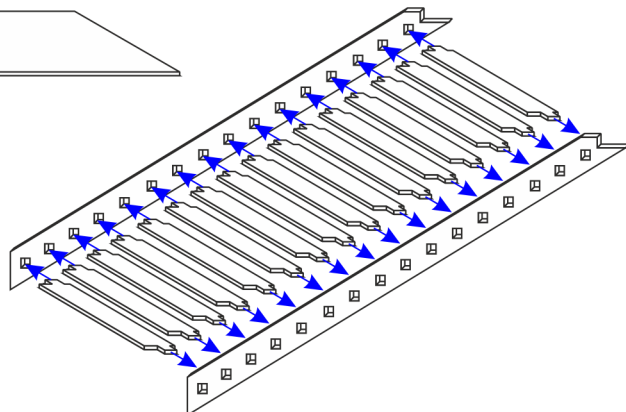

Care needs to be taken when assembling the stairs. Start with LCC 70-125 because they are easier and will help with learning how to do it. Cut out the parts from spruce and clean them up. If needed dry assemble the steps before gluing them in. Care has been taken to make sure the stairs go into the slots in the railings easily. However that means glue is required for permanent assembly.

It is extremely important to ensure that the steps are glued with the longer protrusion facing forward (or down the slope). Furthermore it is crucial that lower step railings are used in the correct orientation. The length of material above the step holes should be larger above the step than below. Refer to the diagram on previous page for visual aid in positioning. Do not glue in the landing floors into LCC 70-128 just yet.

Next step is to glue the balustrades to the staircases. Use the bottom most edge of the staircase railing to align the balustrade. All of the railings should be flush with the balustrades on their bottom edges. The shorter balustrades for the lower staircases should be glued to the staircases with the thinner baluster on the landing end of the staircase. Glue in the landing floors now. Make sure that they are flush with the bottom edge of LCC 70-126 as well as the corner. It is not a problem if the flood does not go all the way into the slot but it must be glued flush with the corner.

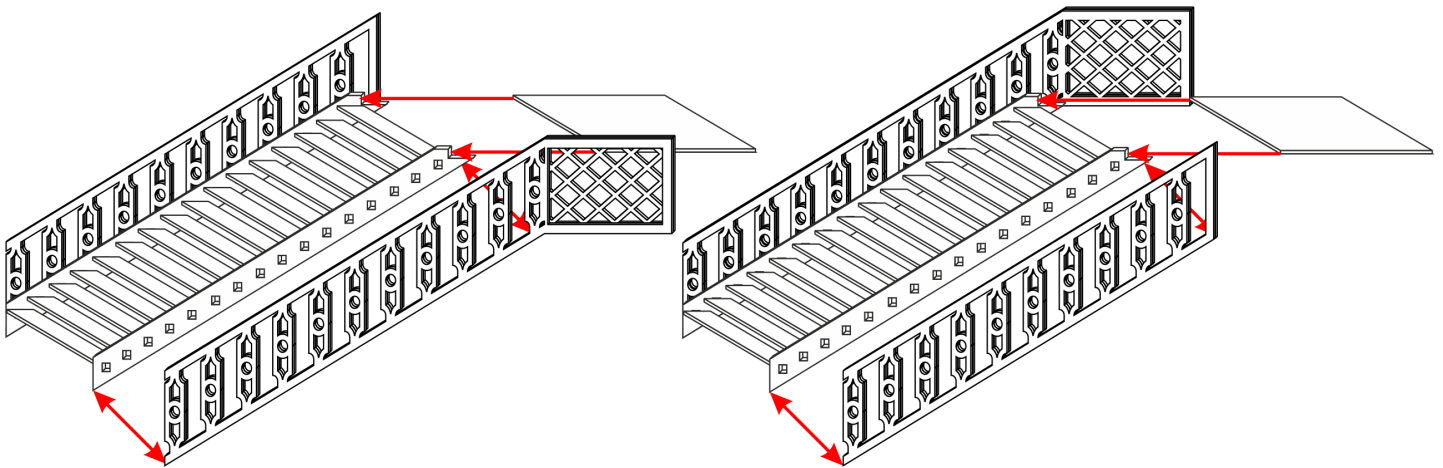

### FINAL ASSEMBLY

After both staircases and the middle span have been assembled it is time to put it all together. Dry fit and practice the assembly before applying glue. General rule of thumb is that the balustrades should come together without gaps and the top edges should be flush with each other. If the landing is slightly crooked it will not be massively detrimental to the final look of the model. However if the railings are assembled with gaps or not flush it will show badly on the finished model.

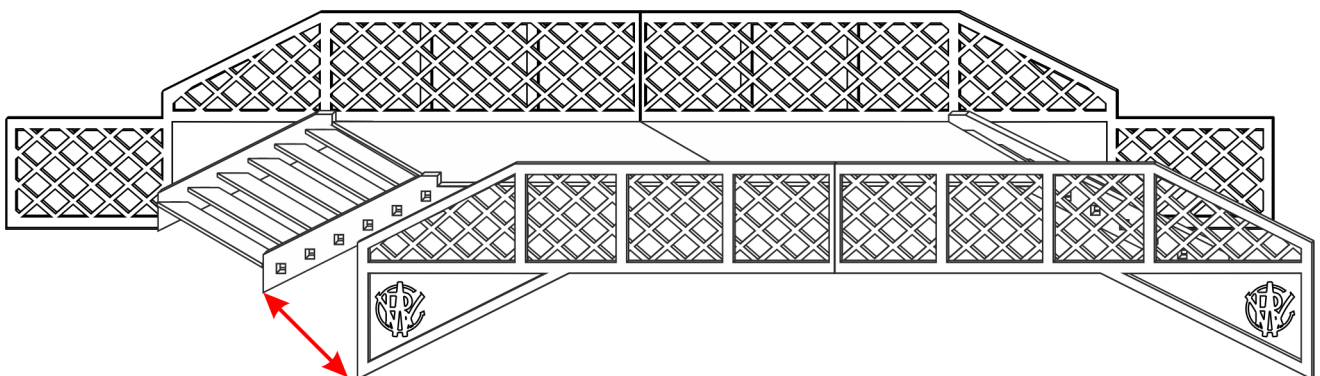

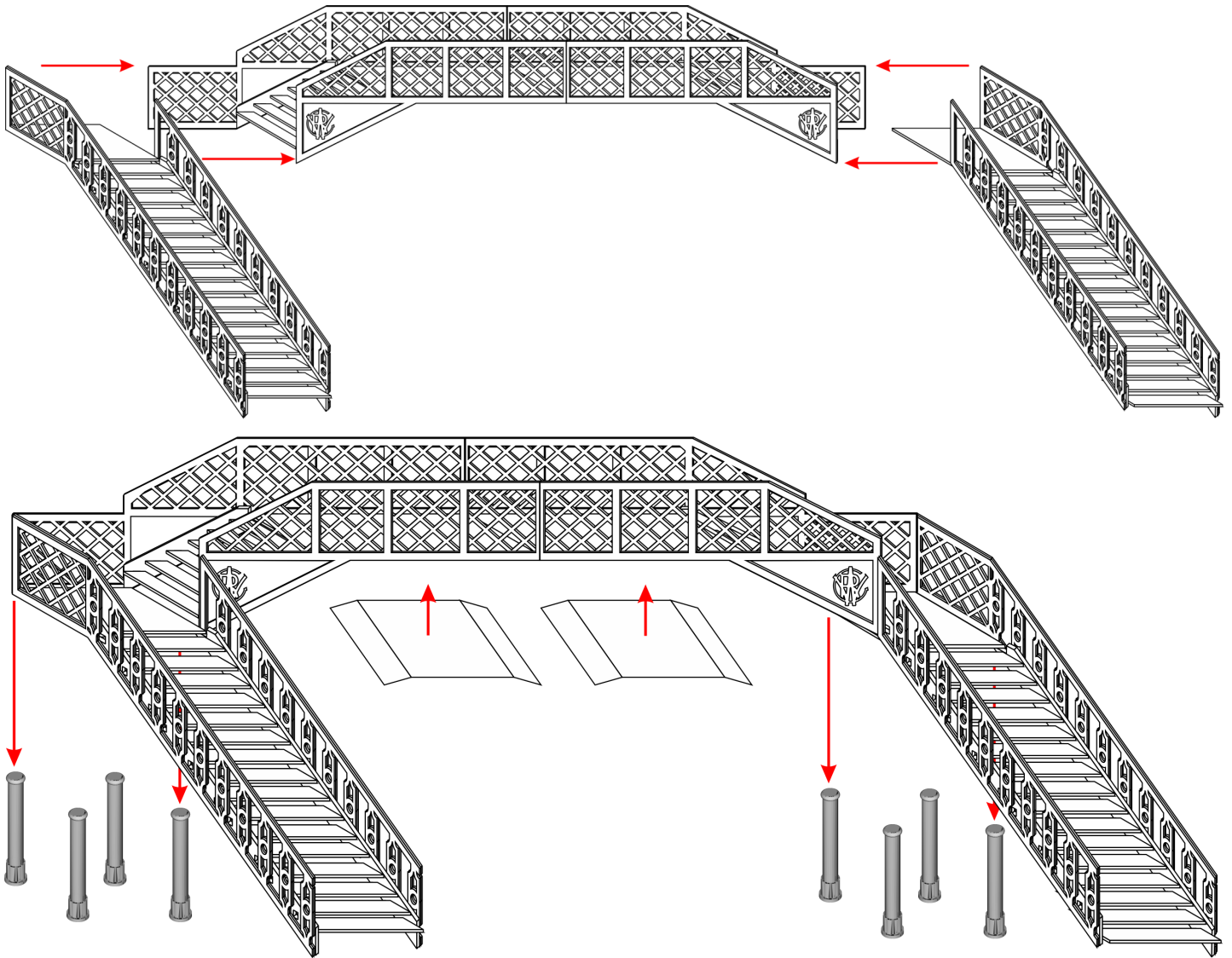

Glue the prepared staircases into the middle span. Making sure that all the gaps are equal on both sides as well as the corners are flush.

Prototype of the footbridge this model is based on was fitted with smoke deflectors and they are supplied as an optional part.

Last step is to glue the columns bottom of the landing floor. Due to how we print them there is a little bit of flashing on the bottom edge of the column. File it away with a fine file or sand paper until the flashing is invisible. The columns are made with photosensitive resin which cannot be exposed to high temperatures or too much UV light. They are reasonably flexible and should not crack easily (do not bend them however). If there are any cracks, voids, or warping/bend in the columns this is a manufacturing fault. We inspect them before packing but there is a possibility a defective column was missed. Please get in touch with us for a replacement if you find a defective column.